

Operating Instructions

4KA72X030W01

Ver:01

2007.11

This sheet provides brief operating instructions of the EN01 type module. For details, Please refer to the User's Operation Manual.

● Dimensions:

Unit: mm(1inch=25.4mm)

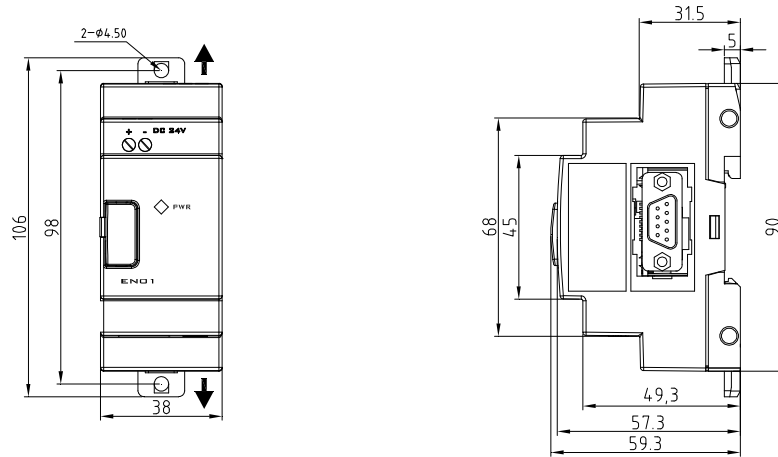

● Mounting:

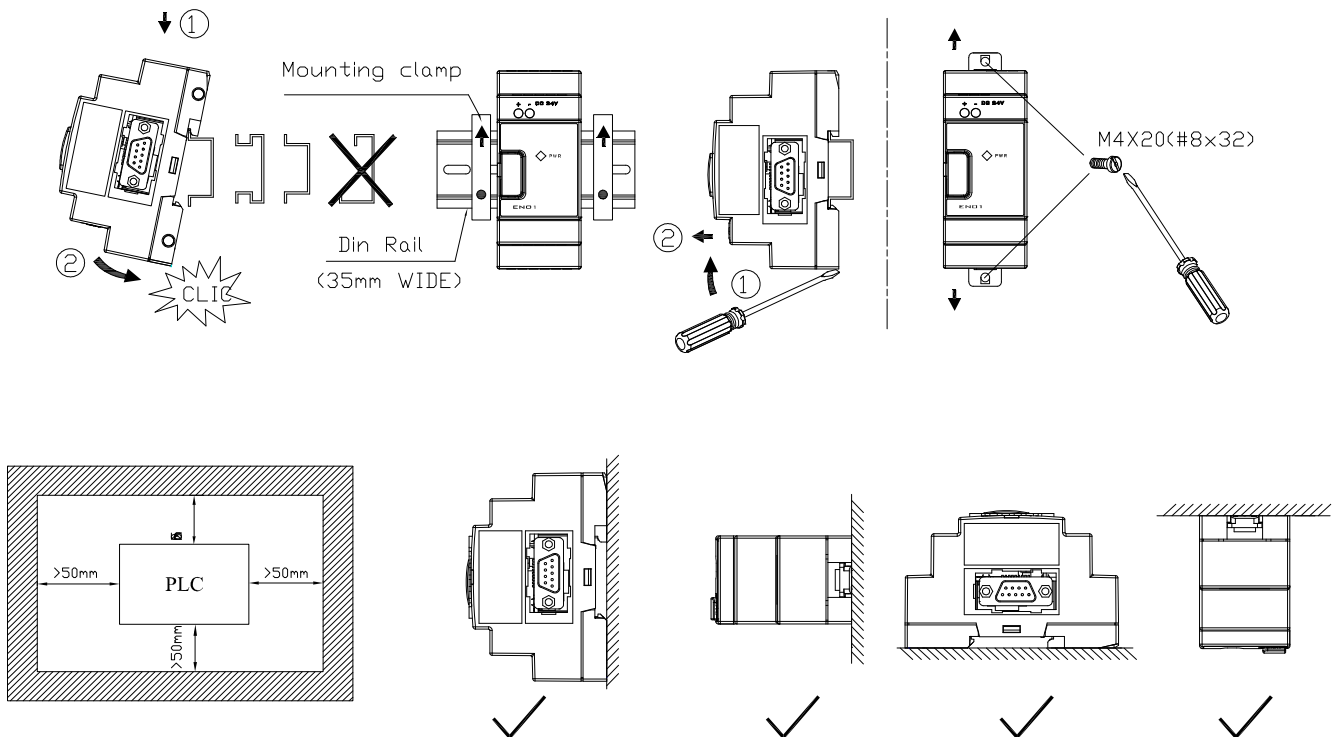

● Wiring:

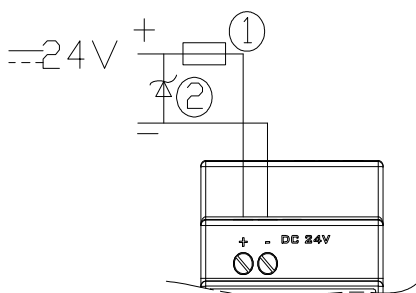

- : A quick-blowing fuse, circuit-breaker or circuit protector.
- : Surge absorber.

Communication (product EN01):

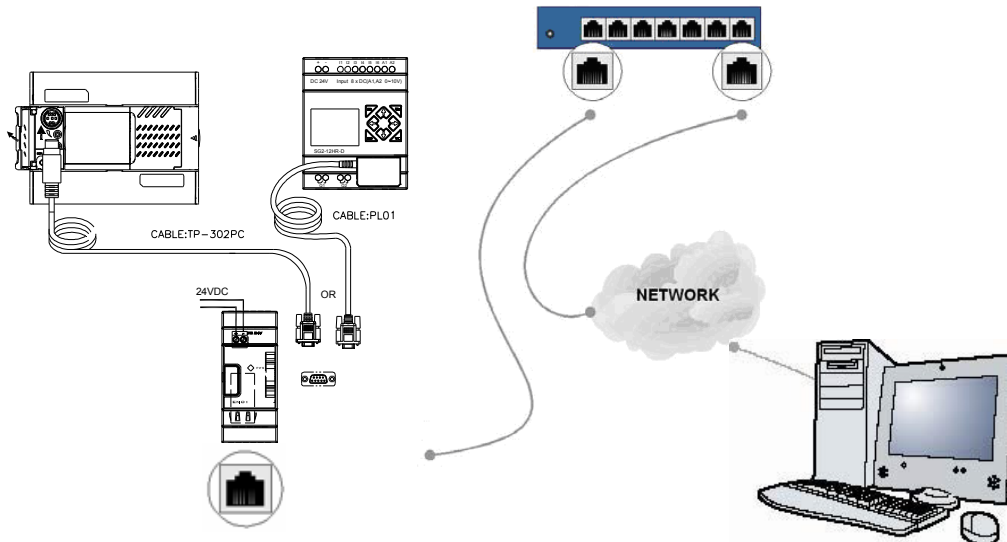

Verification Check: If powered up correctly, the EN01 Evaluation Board power LED indicator lights red and remains on.

● Install Device Installer:

1. Select dotnetfx.exe and Run.
2. Select XPortInstallerSetup.msi and Run.
3. Select red32bit_3.0.0.2.exe and Run.

Note: After you complete the installation, Please restart your Computer.

● Configure:

You can use Local area network or Ethernet to Configure this module. In the Ethernet this module need to have the IP address that can visit; You can obtain the IP address through the Network address Translation or The manager of the Ethernet. In the Local area network, please be sure to follow the procedures given below.

1. Click **Start** in the Windows Taskbar, → **Programs** → **XPortInstaller** → **XPortInstaller**.

2. Click the **Search** icon  and choose it.

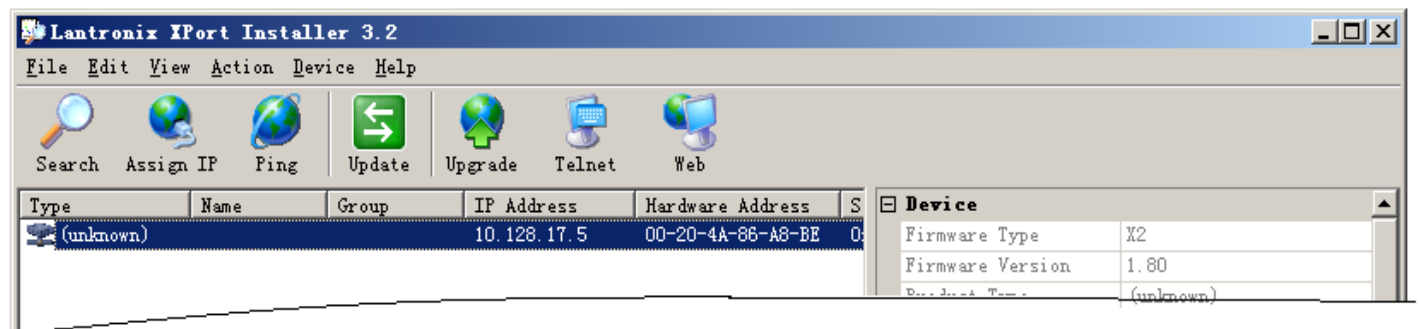

a. Hardware Address

The format: 00-20-4A-XX-XX-XX, where the XXs are unique numbers assigned to the product.

b. IP Address

Your EN01 must have a unique IP address on your network. The systems administrator generally provides the IP address, subnet mask, and gateway. The IP address must be within a valid range, unique to your network, and in the same subnet as your PC. The format: 0.0.0.0 (e.g. 10.128.19.119) .

3. Click the **Assign IP** icon .

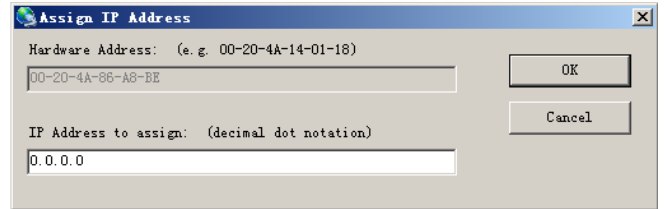
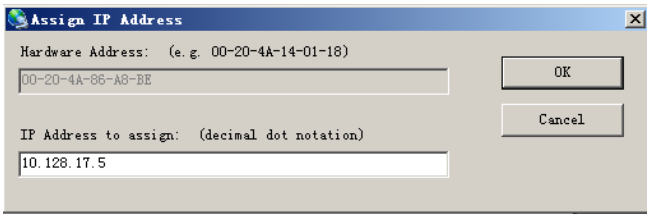



Click the **Assign IP** icon
the **IP address Format** and click **OK**

Note: Enter the **IP address Format: 0.0.0.0**, Click **OK**. Wait for 10 Sec. the window displays in your window. Click **OK**.

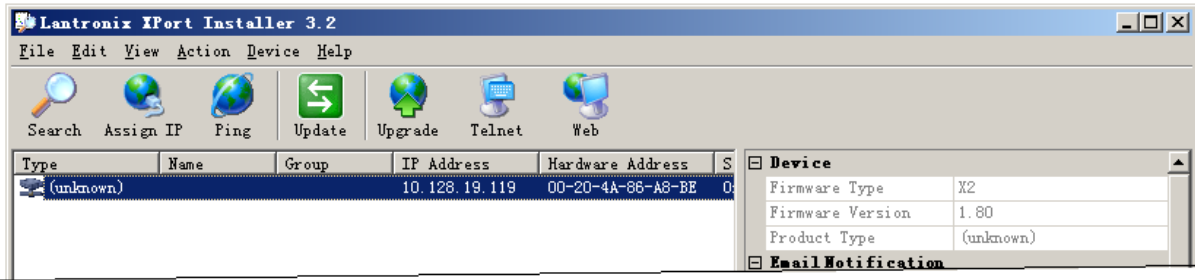

4. Click the **Search** icon  choose it.



5. Click the **Ping** icon  → **Ping** button. The results display in the Status area, make sure the unit is properly attached to the network and that the IP address assigned is valid for the particular network segment you are working with. Click the **Close** button

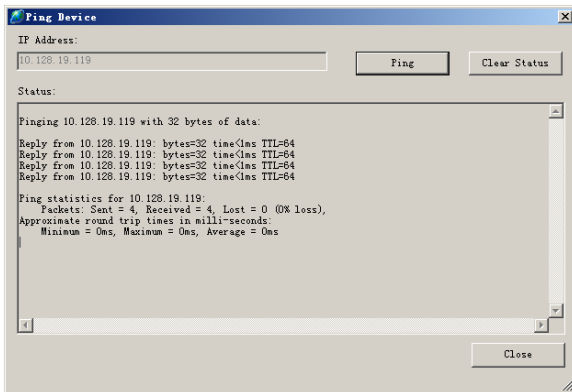

6. Click **Ports**. Rework the **Baud Rate** member, **Data Bits** member, **Stop Bits** member, But make sure these members accord with the Main type module. Write down the **Local Port** member: **10001**; When you are finished click **OK**. Click the **Update Settings** button to save your settings.

Note1: We recommend **Baud Rate: 19200**; **Data Bits: 8**; **Stop Bits: 1**; **Parity bit: no parity**.

Note2: When you click the **Update Settings** button to save your settings, the "status:online" will turn to "status:busy"; Wait for 5 Sec. the "status:busy" will turn to "status:online". After this you are **configuring** successful

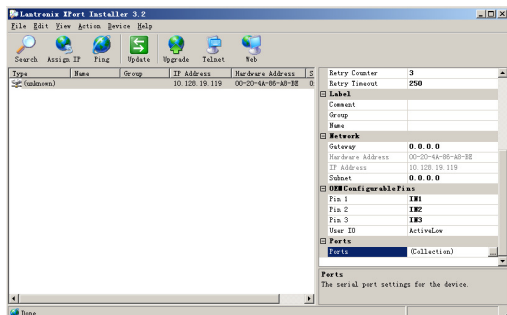

Click **Ports**

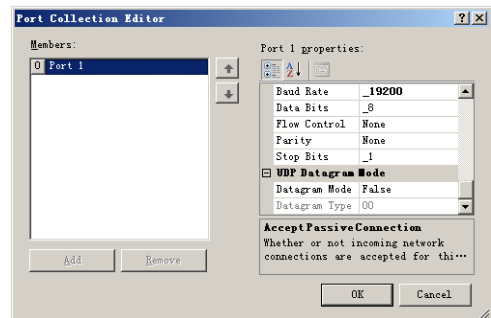

7. Click **Start** in the Windows Taskbar, → **Programs** → **Iantronix** → **Redirector** → **Configuration**. Click **Com Setup** button, A **Port Setup** dialog box displays, Click all the logical ports to which the PC will be redirected.

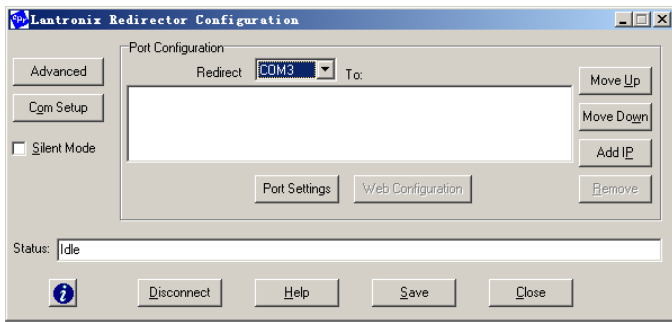

Click **Com Setup**

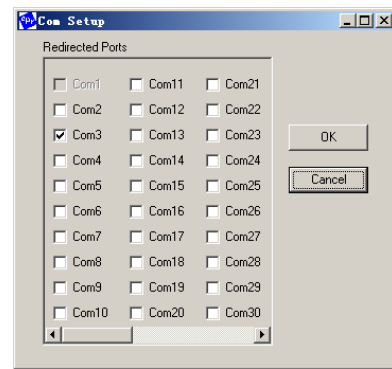

Note: The Host member is the Automation obtain IP to your unit (e.g. 10.128.19.119) ;The TCP Port member is the **Local Port member: 10001**

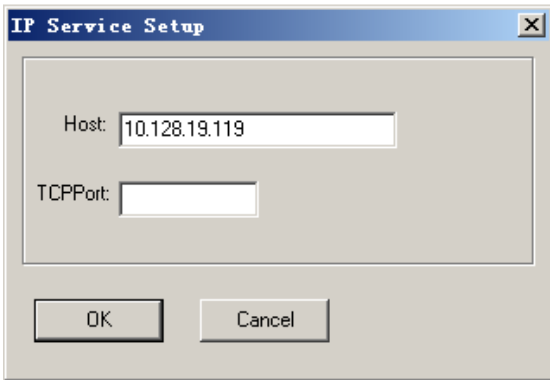

Enter the **hardware address**

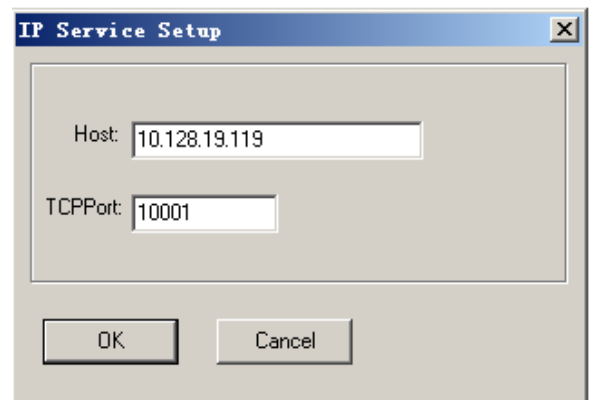
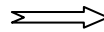

Enter the **Local Port member** and click **OK**

9. Click **Port Setting** button. Choose the **Raw Mode** option and click **OK**

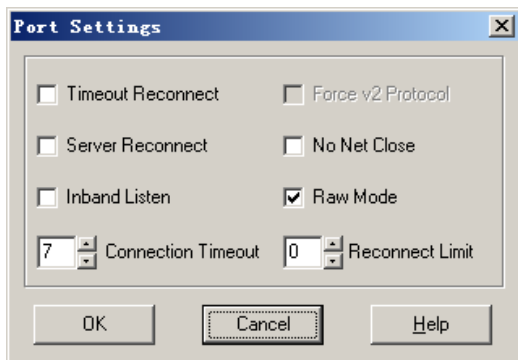

10. To hide the pop-up window, check **Silent Mode** on the Com Port Redirector Configuration window.

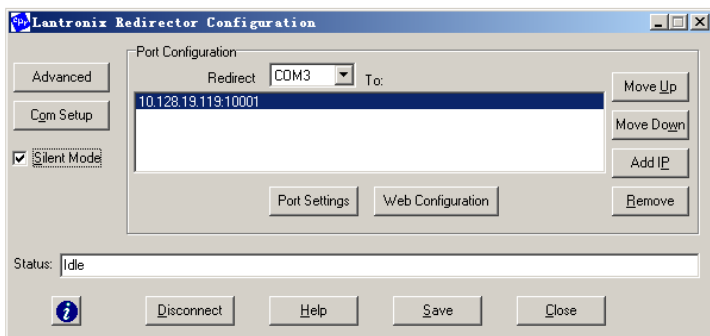

11. Click **Save** button and Closed

Note: After completing this **Configure**, you can Link

and control your product. Choose: **Baud Rate: 19200; Data Bits: 8; Stop Bits: 1; Parity bit: no parity.**

Choose the **Com port** and click **Link** button.

